

TERMINAL BLOCK, DOUBLE ROW

672 RZ XX

Replace "XX" with 01 through 24 for number of poles
9/16 (.563) Pitch



Wire Range

- **Standard** (binding) and **PSB** screw, **#12 - #14** AWG copper only, torque 16 lb-in
- Listed lug (crimp type ring, spade, or fork terminal), **#10-22** AWG, torque 16 lb-in
- **3765** and **3767** (SEMS) screw options, **#12 - #14** AWG copper only, torque 16 lb-in

Electrical Ratings

- Amps
 - 30A with Listed ring lug or unprepared wire (Based on NEC Code, 75°C columns)
- 600 Volts AC/DC (UL 1059 Class C, Use Group – General Industrial)
- Short Circuit Current Rating: 10,000A (Default)
- Approved for Factory and Field Wiring.









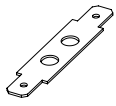

Agency Compliance

- UL Recognized, UL 1059 Terminal Block Standard, File No. XCFR2.E47811
- CSA Certified, CSA C22.2 No. 158, File No. LR19766
- CE compliant, IEC 60947-7-1
- RoHS Compliant

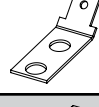
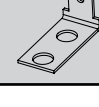
Material Information

- Insulator base:
 - Thermoplastic
 - Flammability rating of insulator base UL94V0
 - Insulator base temperature rating: -40°C to 125°C (UL RTI)
- Connector - Brass, tin plated
- Drive screw (Rivet): Stainless Steel
- Screw, #8-32 Binder head, Phil-Slot: Steel, nickel plated

Hardware Options

| Catalog # | Product Description | Images | |
|-----------|------------------------------------------------------------|--------------------------------------------------------------------------------------|---------------------------|
| KT55 | Full Quick Connect (0° Flat) |  | Reference |
| KT56 | Full Quick Connect (45° Flat) |  | |
| KT57 | Full Quick Connect (90° Flat) |  | |
| KT61 | Half Quick Connect (0° Flat) |  | |
| KT62 | Half Quick Connect (45° Flat) |  | |
| KT63 | Half Quick Connect (90° Flat) |  | |
| ST | Full Solder | No Image | Reference |
| 3/4 ST | Half Solder | No Image | |
| J 602 | Line-to-Line Jumper |  | Reference |
| 3786 | SEMS Pressure Saddle Screw |  | Reference |
| 3787 | SEMS Pressure Saddle Screw with external tooth lock washer | | |
| PSB | Phil-Slot Brass Screw | -- | -- |
| | Covers - Top Mounted |  | Reference |
| | Making & Insulator Strips - Sub-Mounted |  | Reference |
| | Marking Strips - Top Mounted |  | Reference |

Drawing

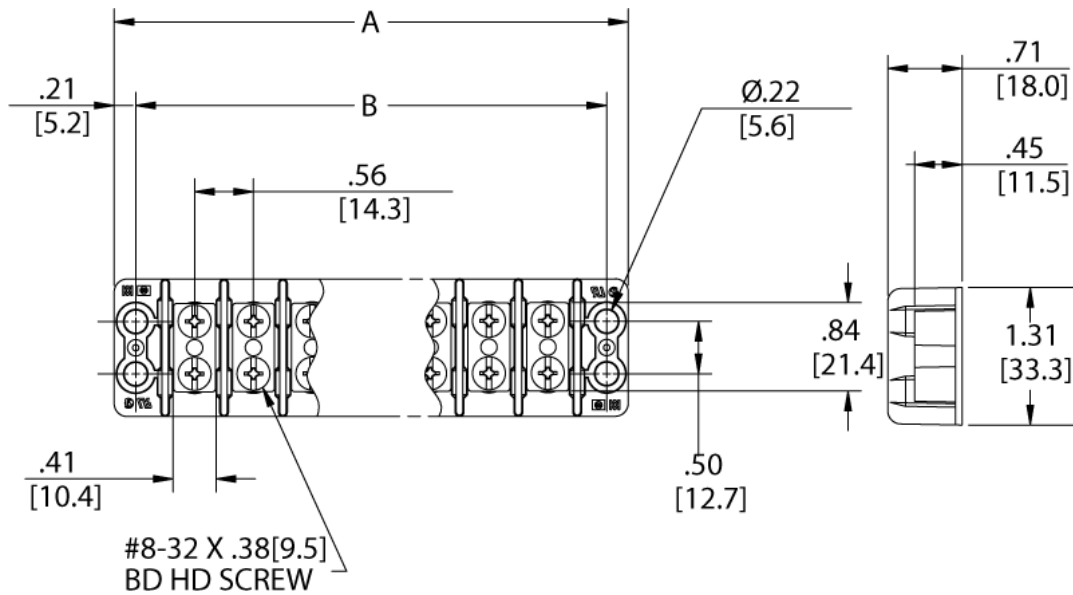

Mounting:

- Mounting torque to be determined in end use application not to exceed 20 lb-in.

| Dimensions | | | | Dimensions | | | |
|------------|------------|------|------|------------|------------|-------|-------|
| Catalog # | # of Poles | A | B | Catalog # | # of Poles | A | B |
| 672 RZ 01 | 1 | 1.54 | 1.13 | 672 RZ 13 | 13 | 8.29 | 7.88 |
| 672 RZ 02 | 2 | 2.10 | 1.69 | 672 RZ 14 | 14 | 8.85 | 8.44 |
| 672 RZ 03 | 3 | 2.66 | 2.25 | 672 RZ 15 | 15 | 9.41 | 9.00 |
| 672 RZ 04 | 4 | 3.22 | 2.81 | 672 RZ 16 | 16 | 9.97 | 9.56 |
| 672 RZ 05 | 5 | 3.78 | 3.38 | 672 RZ 17 | 17 | 10.54 | 10.13 |
| 672 RZ 06 | 6 | 4.35 | 3.94 | 672 RZ 18 | 18 | 11.10 | 10.69 |
| 672 RZ 07 | 7 | 4.91 | 4.50 | 672 RZ 19 | 19 | 11.66 | 11.25 |
| 672 RZ 08 | 8 | 5.47 | 5.06 | 672 RZ 20 | 20 | 12.22 | 11.81 |
| 672 RZ 09 | 9 | 6.04 | 5.63 | 672 RZ 21 | 21 | 12.79 | 12.38 |
| 672 RZ 10 | 10 | 6.60 | 6.19 | 672 RZ 22 | 22 | 13.35 | 12.94 |
| 672 RZ 11 | 11 | 7.16 | 6.75 | 672 RZ 23 | 23 | 13.91 | 13.50 |
| 672 RZ 12 | 12 | 7.72 | 7.31 | 672 RZ 24 | 24 | 14.47 | 14.06 |

MM = DIM X 25.4