

Studded Power Block, Feed Thru

ST722BM6XX (Back Mount)

Replace "XX" with 02 through 06 for number of poles

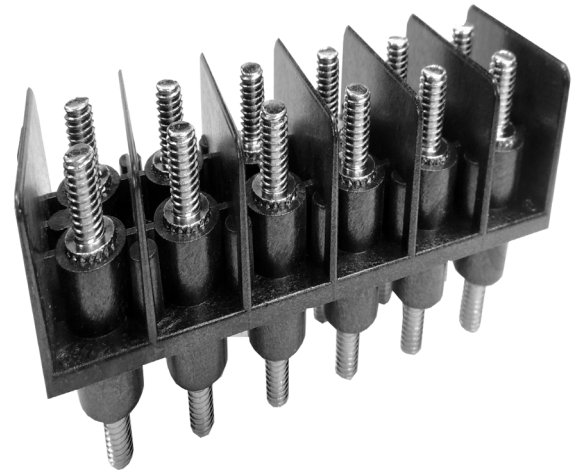

Mounting Screws Included

Wire Range

- 2/0 - #8 AWG with listed terminals
- Wires #2 and larger may require narrow lugs

Electrical Ratings

- 175A Dual Hole Lug
- 115A Single Hole Lug
- Based on NEC Code, 75°C Wire
- 300 Volts AC/DC (UL 1059 Class B – Commercial Appliances and Class C - General Industrial)
- Short Circuit Current Rated for 10,000 Amps.
- Factory and Field Wiring

Agency Compliance

- UL Recognized, UL 1059 Terminal Block Standard, File No. XCFR2.E62806
- CSA Certified, CSA C22.2 No. 158, File No. LR19766
- CE compliant to IEC 60947-7-1
- RoHS Compliant

Material Information

- Studs: M6: Brass, Nickel plated
- Insulator base: Glass-filled polycarbonate (Thermoplastic)
- Maximum insulator base temperature: 125°C (257°F) UL RTI
- Storage and transportation temperature range: -35°C to 110°C (-31°F to 230°F)
- Flammability rating of insulator base: UL 94 V-0
 - Use outside these ratings to be evaluated in the end-use application.
- Application Torque: 35 in-lbs
- Panel Mountable: #6 fastener, torque to 10 lb-in max

Hardware Options

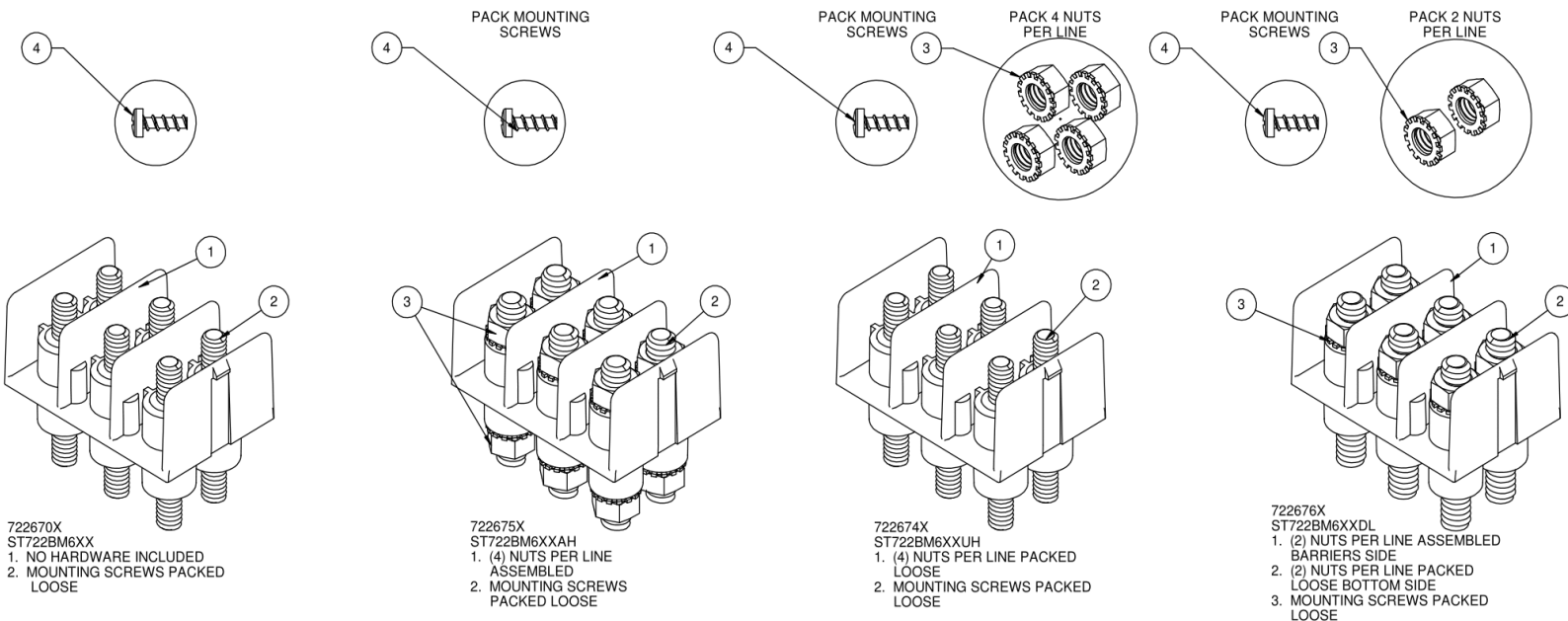

Accessories

- Cover: order C722XX (XX = line length 1 through 6)

Mounting Cutout:

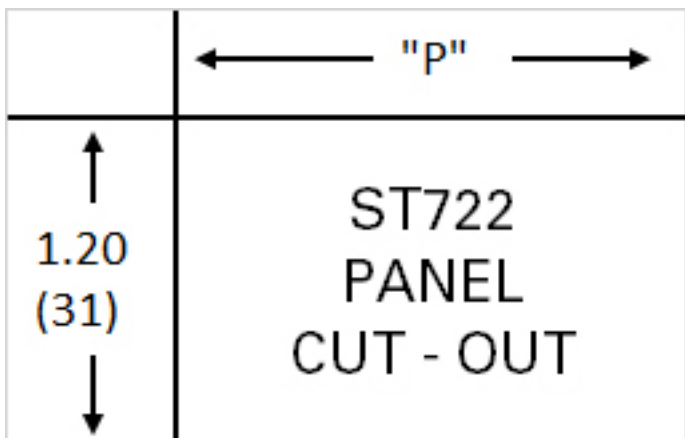

	"P"	
1-Line	.62	15.7
2-Line	1.35	34.3
3-Line	2.08	52.8
4-Line	2.81	71.4
5-Line	3.54	89.9
6-Line	4.27	108.5

Product Data Sheet



Drawing

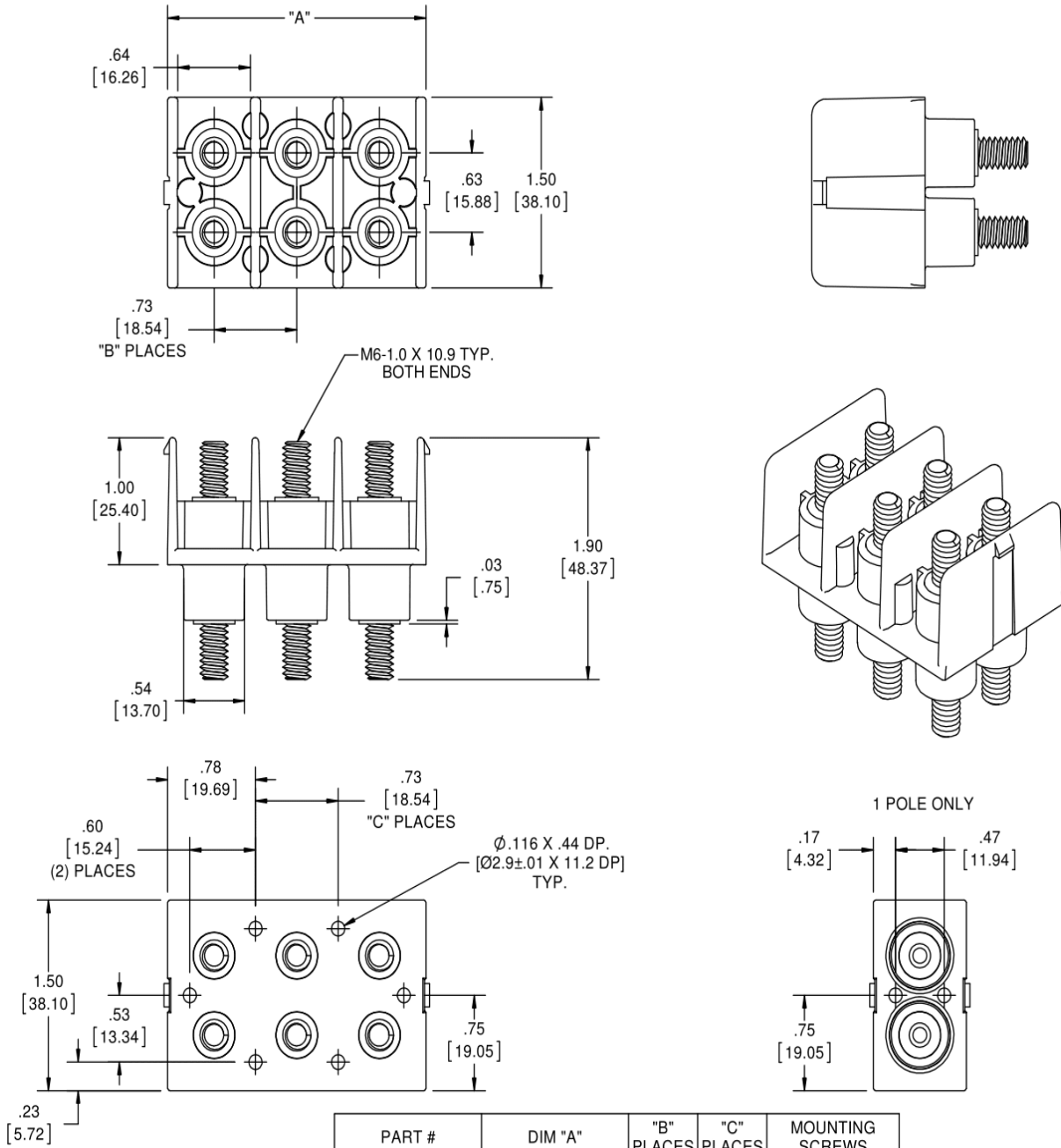

PART #	DIM "A"	"B" PLACES	"C" PLACES	MOUNTING SCREWS
ST722BM601	.82 [20.83]	-	-	2
ST722BM602	1.55 [39.37]	1	-	4
ST722BM603	2.28 [57.91]	2	1	4
ST722BM604	3.01 [76.45]	3	2	4
ST722BM605	3.74 [95.00]	4	3	4
ST722BM606	4.47 [113.54]	5	4	6